

# Application Note

## Bidirectional Counter (FSM)

### AN-CM-286

#### Abstract

*This application note shows how to build bidirectional counters having different interface methods designed in GreenPAK.*

*This application note comes complete with design files which can be found in the References section.*

---

---

## Bidirectional Counter (FSM)

### Contents

Abstract .....	1
Contents .....	2
Figures.....	2
1 Terms and Definitions.....	3
2 References .....	3
3 Introduction.....	4
4 "16-bit FSM with SPI Output" .....	4
5 "16-bit FSM with I2C Output" .....	10
6 "9-bit FSM with Parallel Outputs" .....	12
7 Conclusions .....	13
Revision History .....	14

### Figures

Figure 1: "16-bit FSM with SPI Output" .....	4
Figure 2: Functionality of "16-bit FSM with SPI Output" .....	5
Figure 3: "16-bit FSM with SPI Output, OVF and Initial Value's Setting Functions" .....	6
Figure 4: Functionality of "16-bit FSM with SPI Output, OVF and Initial Value's Setting Functions" ....	7
Figure 5: Functionality of "16-bit FSM with SPI Output, OVF and Initial Value's Setting Functions" OVF Event Happened .....	7
Figure 6: "16-bit FSM with SPI Output, Zero Detector and Initial Value's Setting Function" .....	8
Figure 7: Functionality of "16-bit FSM with SPI Output, OVF and Initial Value's Setting Functions" ....	9
Figure 8: Functionality of "16-bit FSM with SPI Output, OVF and Initial Value's Setting Functions" ZD Event Happened.....	9
Figure 9: "16-bit FSM with I2C Output" .....	10
Figure 10: Functionality of "16-bit FSM with I2C Output" .....	11
Figure 11: Zoomed Functionality of "16-bit FSM with I2C Output" .....	11
Figure 12: "4-bit FSM with Parallel Outputs" .....	12
Figure 13: Functionality of "4-bit FSM with Parallel Outputs (Based on Glue Logic)" .....	13
Figure 14: Functionality of "9-bit FSM with Parallel Outputs" .....	13

---

## Bidirectional Counter (FSM)

### 1 Terms and Definitions

FSM - Finite State Machine

SPI - Serial Peripheral Interface

I2C - Inter Integrated Circuit

DFF - D Flip-flop

LUT - Lookup Table

OVF - Overflow

OSC - Oscillator

IC - Integrated Circuit

DCMP - Digital Comparator

ZD - Zero Detector

CNT - Counter

### 2 References

For related documents and software, please visit:

<https://www.dialog-semiconductor.com/configurable-mixed-signal>.

Download our free [GreenPAK Designer](#) software [1] to open the .gp files [2] and view the proposed circuit design. Use the [GreenPAK development tools](#) [3] to freeze the design into your own customized IC in a matter of minutes. Dialog Semiconductor provides a complete library of application notes [4] featuring design examples as well as explanations of features and blocks within the Dialog IC.

[1] [GreenPAK Designer Software](#), Software Download and User Guide, Dialog Semiconductor

[2] [AN-CM-286 Bidirectional Counter.gp](#), [GreenPAK Design File](#), Dialog Semiconductor

[3] [GreenPAK Development Tools](#), [GreenPAK Development Tools Webpage](#), Dialog Semiconductor

[4] [GreenPAK Application Notes](#), [GreenPAK Application Notes Webpage](#), Dialog Semiconductor

Author: Ivan Vaskiv

**Bidirectional Counter (FSM)**
**3 Introduction**

A counter is a digital circuit which is used for counting input events (pulses, edges). Digital electronic counters are usually built from a series of flip-flops connected in cascade.

This application note is intended to show how to build bidirectional counters (FSM) having different interface methods designed in GreenPAK. The methods to be implemented are:

- 16-bit FSM with SPI output
- 16-bit FSM with I2C output
- FSM with parallel outputs (based on glue logic)

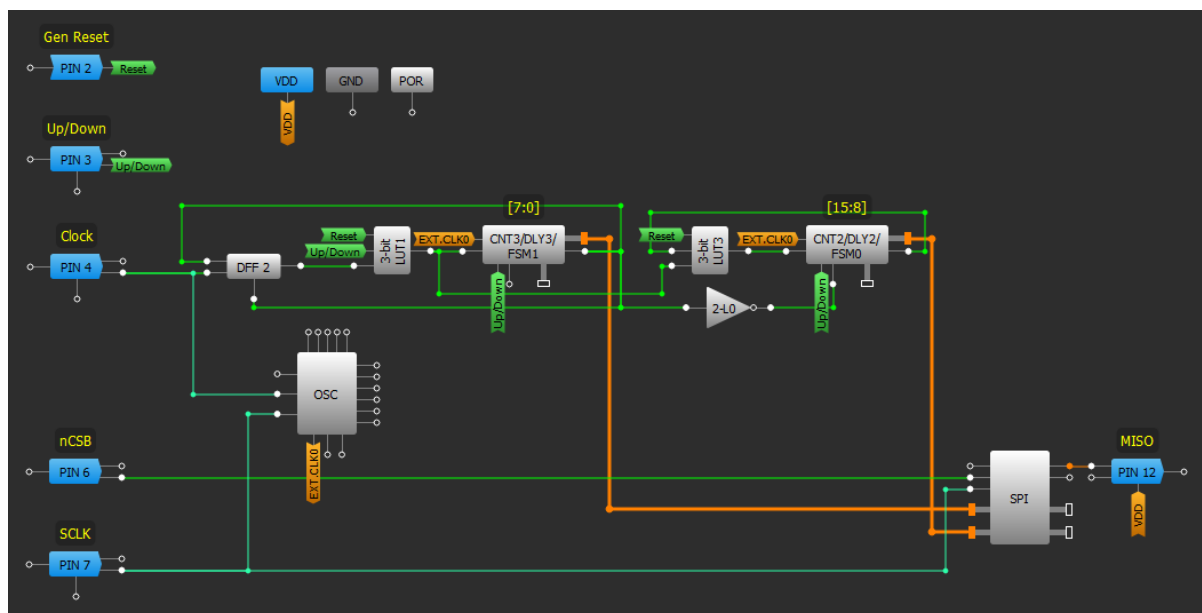
**4 "16-bit FSM with SPI Output"**

**Figure 1: "16-bit FSM with SPI Output"**

The "16-bit FSM with SPI output" counts input clocks in an internal 16-bit register (FSM0, FSM1), at any time a user can read the value via SPI, reset the 16-bit register, or change direction of counting. The design is implemented in SLG46140, or SLG46620 as well.

Let's see how it works. The 16-bit counter is implemented using two counters (FSM0 and FSM1 blocks) with additional logic, since SLG46140 doesn't have 16-bit FSM. Bits 15 – 8 are stored in FSM0, Bits 7 – 0 in FSM1. Both FSMs are connected to the SPI block, which can output serial data via SPI. The direction of counting is controlled by Up/Down pin. If this pin is HIGH, the system counts UP, if this pin is LOW, the system counts DOWN. Gen Reset pin is used to reset counter value (active HIGH).

Input clocks come from Clock input. These clocks are applied simultaneously at CLK inputs of FSM1 and FSM0. FSM1 counts each clock, whereas FSM0 counts only when FSM1 counter value is 255 and Up/Down signal is HIGH or when FSM1 counter value is 0 and Up/Down signal is LOW. This functionality is achieved using KEEP input of the FSM0. When this signal is HIGH the counter value of the FSM0 is not changing despite the clock signal. The KEEP input is connected to FSM1 output through an inverter. FSM1 output in turn is HIGH only when counter value is 0 and Up/Down signal is LOW, or when counter value is 255 and Up/Down signal is HIGH.

## Bidirectional Counter (FSM)

Since FSM counter value is reset to counter data when the FSM counter value reaches maximum (255) and FSM1 counter data is 255, FSM1 stops at a max value (255) when counting up and FSM1 UP input signal is HIGH. In order to avoid this situation, DFF2 and 3-bit LUT1 reset FSM1 by the next clock when FSM1 reaches max value and Up/Down is HIGH. If Up/Down is LOW, FSM1 is not reset. The situation is similar with FSM0. This one is also reset to counter data, and when FSM0 reaches max value (16383) it will then start to cause incorrect data. In order to avoid that situation, 3-bit LUT3 resets FSM0 by the next clock when both FSMs reach max value (SPI output code in this situation is 0xFFFF) and Up/Down is HIGH. Both FSMs are not reset if Up/Down is LOW.

D0 – PIN#6 (nCSB)

D1 – PIN#7 (SCLK)

D2 – PIN#12 (MISO)

D3 – PIN#2 (Gen Reset)

D4 – PIN#3 (Up/Down)

D5 – PIN#4 (Clock)

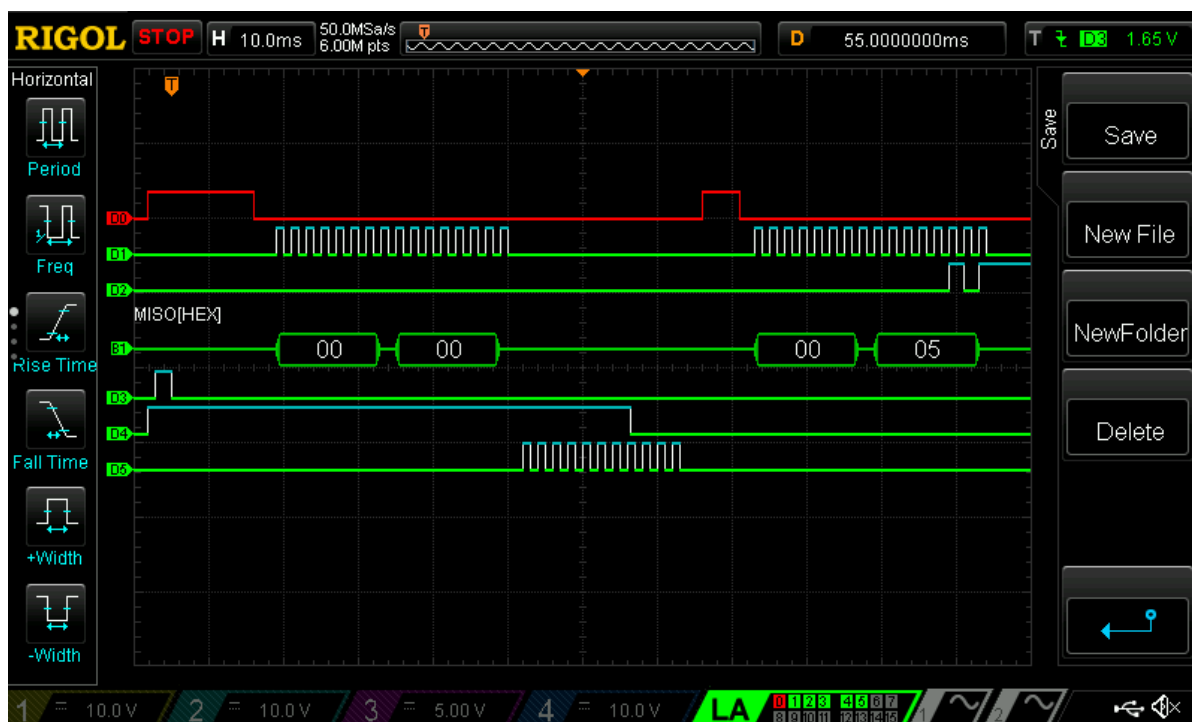

Figure 2: Functionality of “16-bit FSM with SPI Output”

The following design, which is shown on [Figure 3](#), is just a modification of the 16-bit FSM with SPI output. This design can be used if we need to detect an overflow (OVF) event and set the initial value of the 16-bit counter (FSM0 and FSM1).

The initial value of the 16-bit counter is set to ½ maximum value (FSM0 data = 0x7F, FSM1 data = 0xFF) and can be adjusted easily. Initial value setting process takes ~9ms and starts just after the power up of GreenPAK IC, or when High pulse is applied to “Gen Reset” input. During those ~9ms FSM0 and FSM1 receive pulses from the internal OSC and will ignore pulses from Clock input. The initial value depends on CNT0 counter data and Pipe delay “OUT0 PD num” value. CNT0 counts the

## Bidirectional Counter (FSM)

clock from internal oscillator simultaneously with 16-bit counter. Pipe Delay in turn counts output pulses from CNT0. When Pipe Delay OUT0 goes HIGH, the OSC is stopped by this signal (2-L5) and clock signal for 16-bit counter is taken from Clock input. To change the source of clocks, a 3-bit LUT0 is used. Also, when Pipe delay OUT0 is LOW, it forces the 16-bit counter to count DOWN, in order to guarantee the correct direction of counting during initial value's set process. The initial value is determined by the following formula:

$$Initial\ value = 65535 - ((CNT0\ Counter\ data + 1) * Pipe\ Delay\ OUT0\ value - 1)$$

In case of 16-bit counter overflow, an according OVF output will be set and latched. It will be reset after IC reset or when "Gen Reset" or "OVF Reset" signal comes. This function is implemented using the following components: DCMP0, DCMP1, 4-bit LUT0, 2-L4 and DFF2.

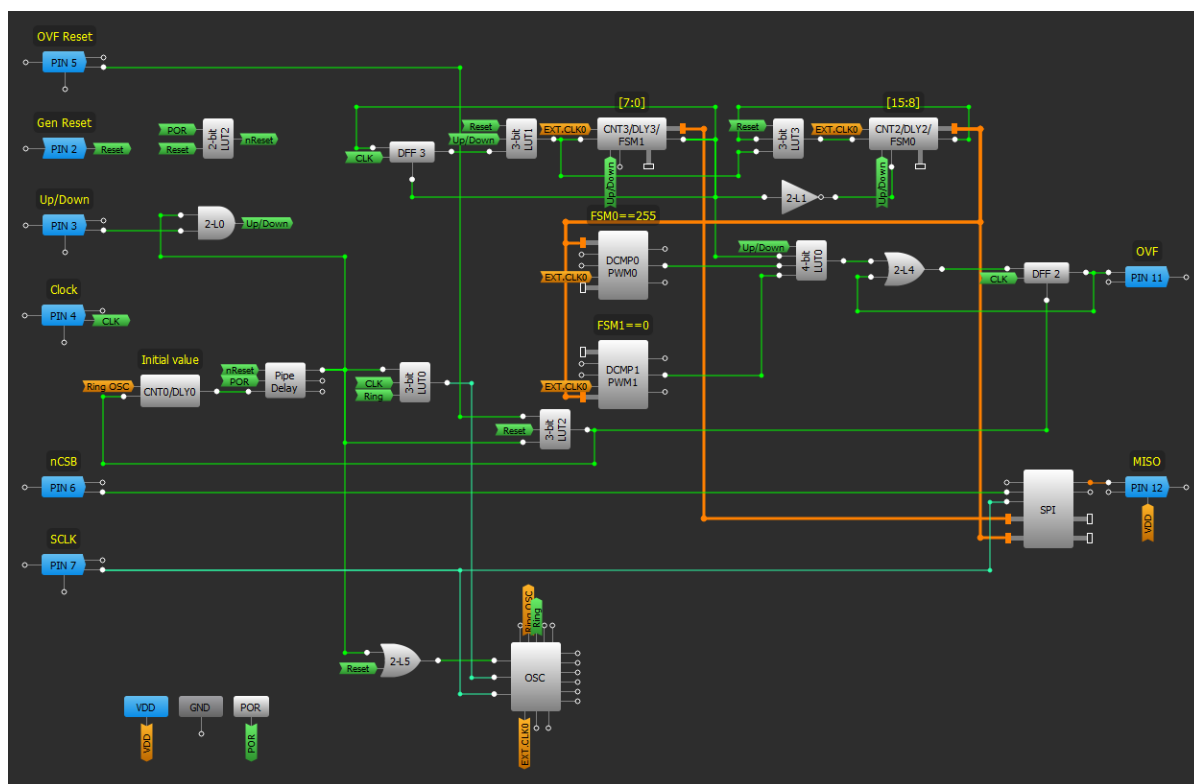

Figure 3: "16-bit FSM with SPI Output, OVF and Initial Value's Setting Functions"

- D0 – PIN#6 (nCSB)
- D1 – PIN#7 (SCLK)
- D2 – PIN#12 (MISO)
- D3 – PIN#5 (OVF Reset)
- D4 – PIN#2 (Gen Reset)
- D5 – PIN#3 (Up/Down)
- D6 – PIN#4 (Clock)
- D7 – PIN#11 (OVF)

Bidirectional Counter (FSM)

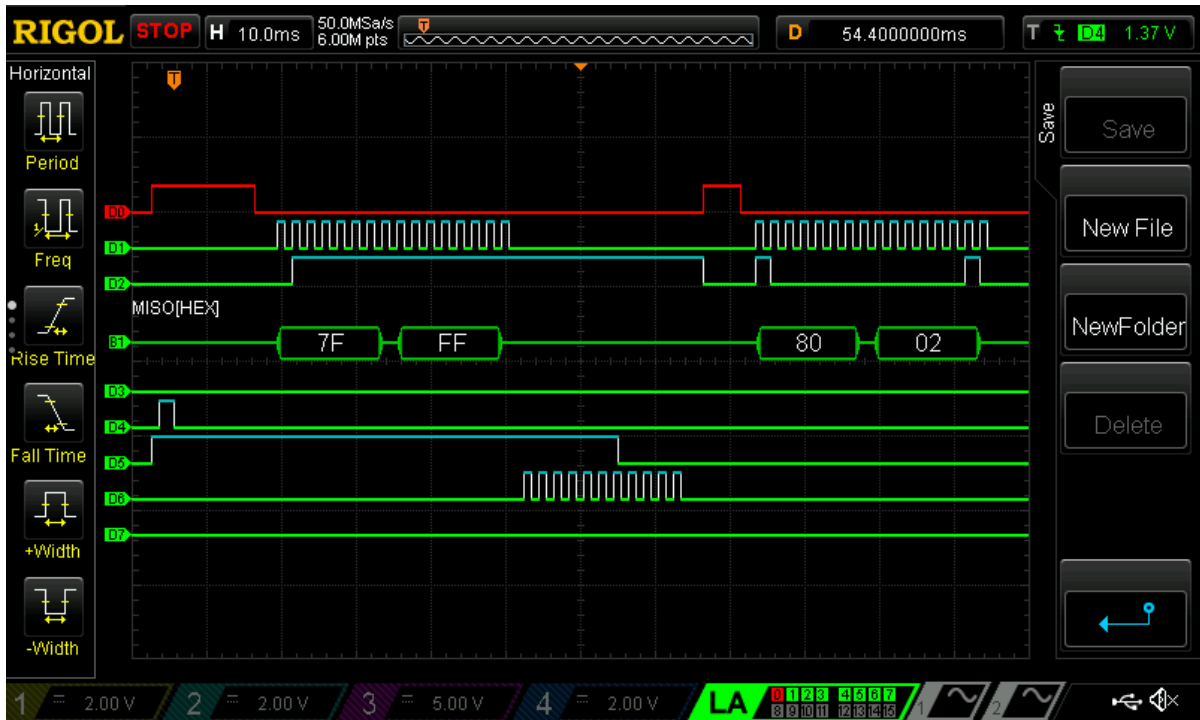

Figure 4: Functionality of “16-bit FSM with SPI Output, OVF and Initial Value’s Setting Functions”

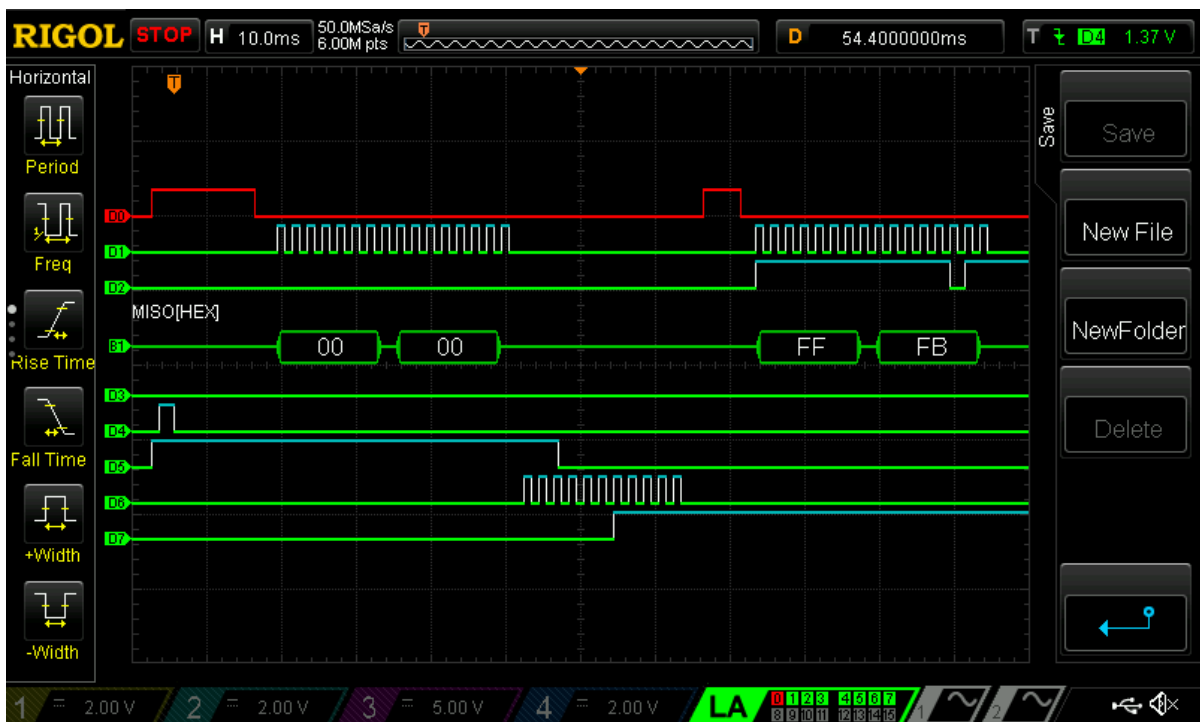

Figure 5: Functionality of “16-bit FSM with SPI Output, OVF and Initial Value’s Setting Functions” OVF Event Happened

The last design which is related to 16-bit FSM with SPI output is “16-bit FSM with SPI output, zero detector and initial value's setting function”.

Bidirectional Counter (FSM)

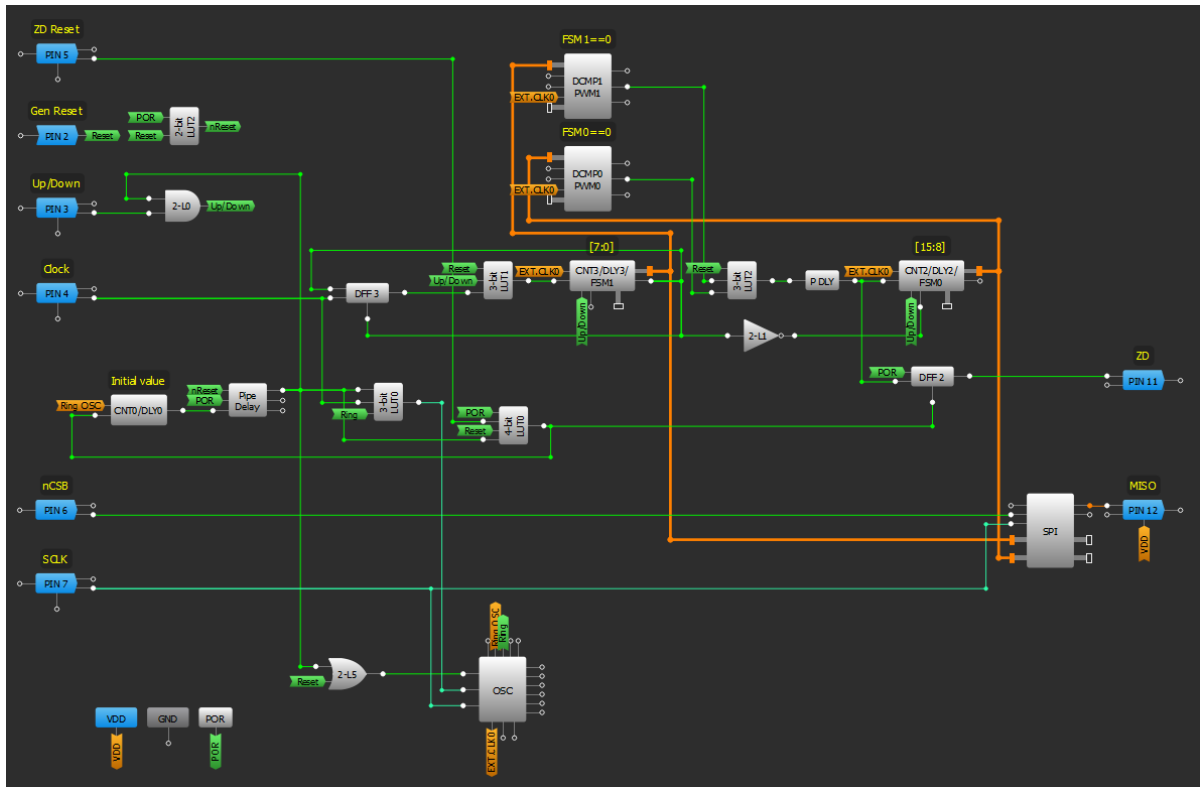
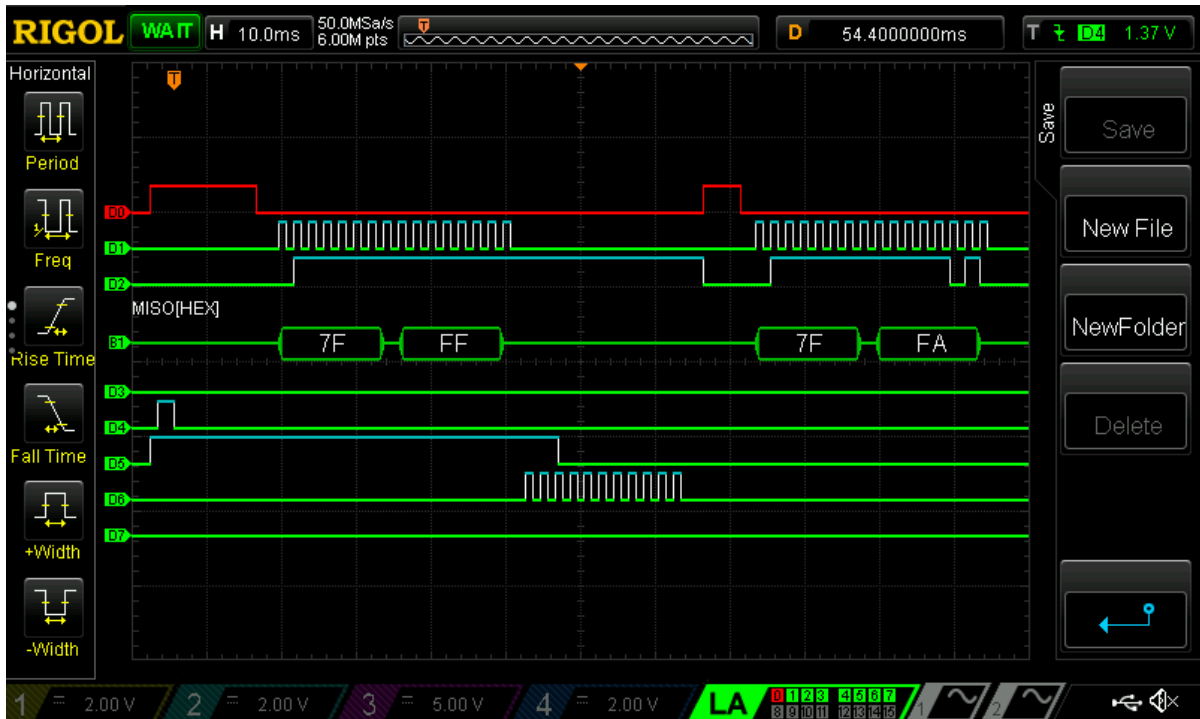

Figure 6: “16-bit FSM with SPI Output, Zero Detector and Initial Value's Setting Function”

When 16-bit counter value is equal to zero, a corresponding ZD output (Zero detector) will be set and latched. It will be reset after IC reset or when “Gen Reset” or “ZD Reset” signal arrives.





### Bidirectional Counter (FSM)

Figure 7: Functionality of “16-bit FSM with SPI Output, OVF and Initial Value’s Setting Functions”

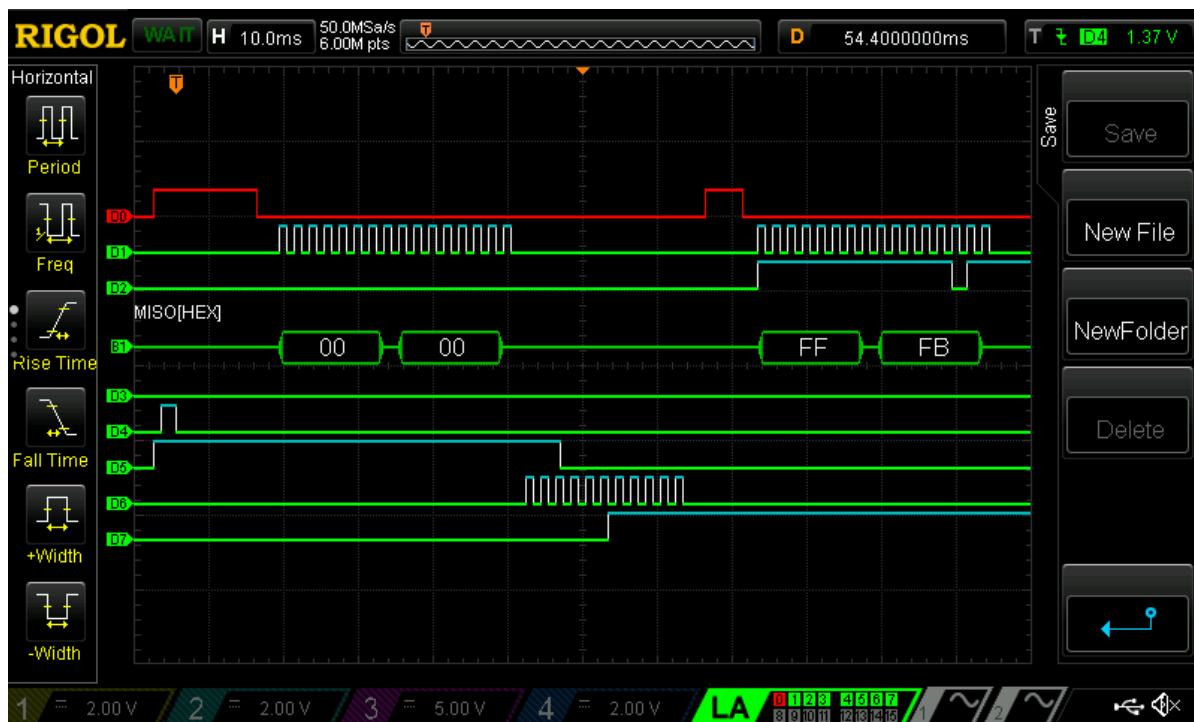
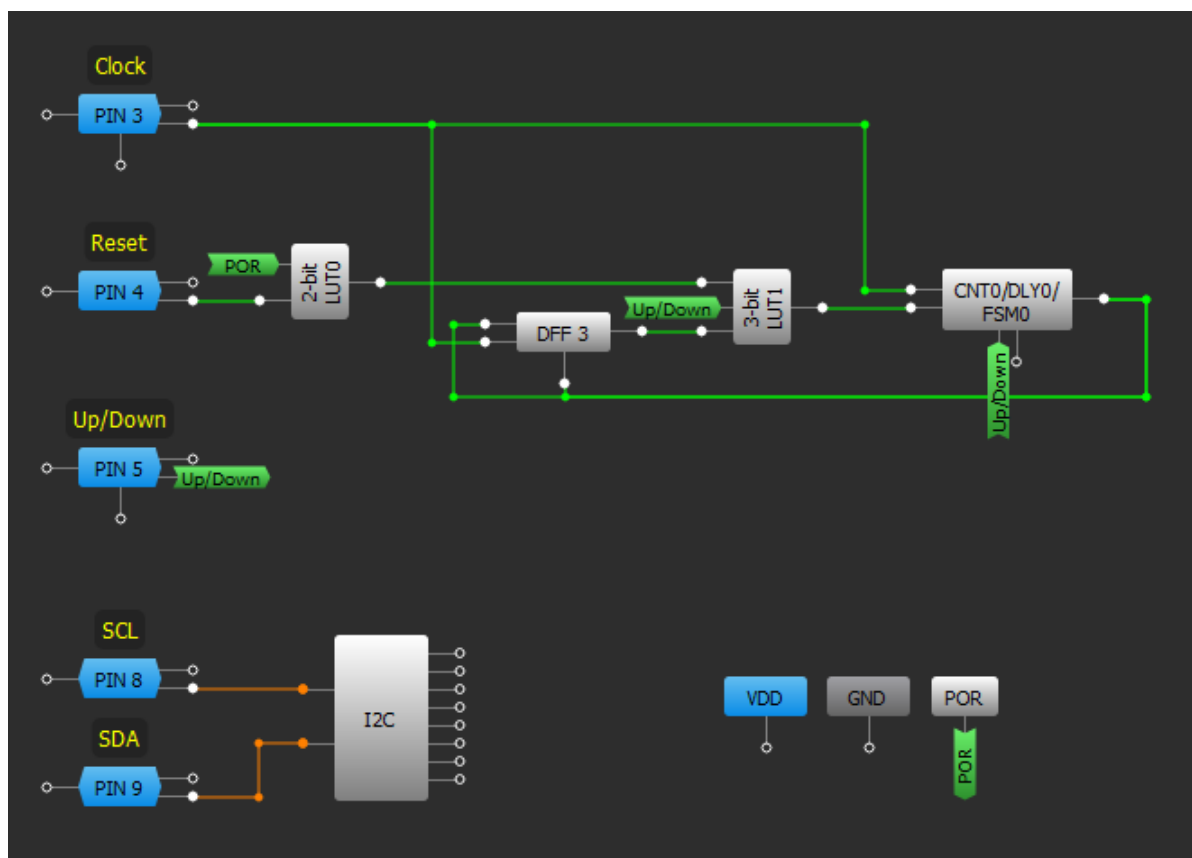

Figure 8: Functionality of “16-bit FSM with SPI Output, OVF and Initial Value’s Setting Functions” ZD Event Happened

## Bidirectional Counter (FSM)

### 5 “16-bit FSM with I2C Output”



**Figure 9: “16-bit FSM with I2C Output”**

This design counts input clocks in an internal 16-bit register (FSM0). At any time the user can read the value via I2C, reset the 16-bit register, or change direction of counting. This design is implemented on SLG46533. There is one more FSM cell which can be used to get one 32-bit register or two independent 16-bit registers. Also, initial value can be set in the same way as in previous designs.

The DFF3 and 3-bit LUT1 have the same purpose as in “16-bit FSM with SPI output”, namely reset FSM0 by next clock when FSM0 reaches max value (0xFFFF) and Up/Down signal is HIGH, since FSM0 stops when it reaches max value and FSM0 UP input is HIGH.

- D0 – PIN#3 (Clock)
- D1 – PIN#4 (Reset)
- D2 – PIN#5 (Up/Down)
- D3 – PIN#8 (SCL)
- D4 – PIN#9 (SDA)

### Bidirectional Counter (FSM)

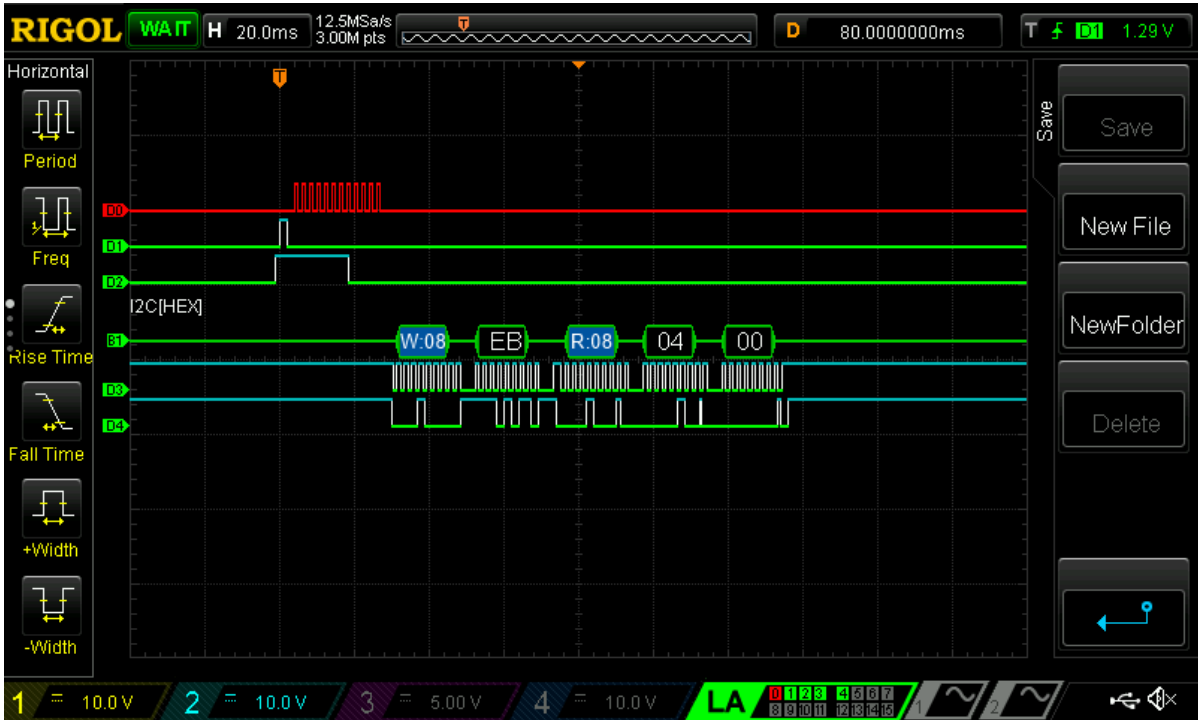

Figure 10: Functionality of “16-bit FSM with I2C Output”

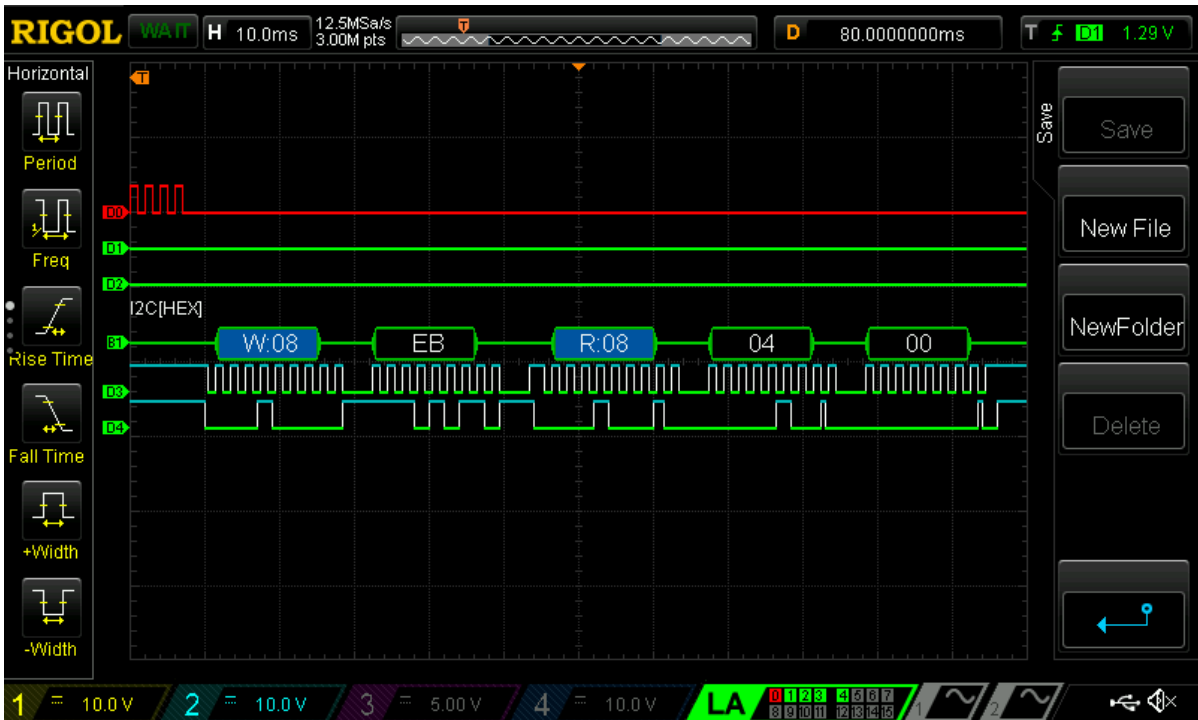
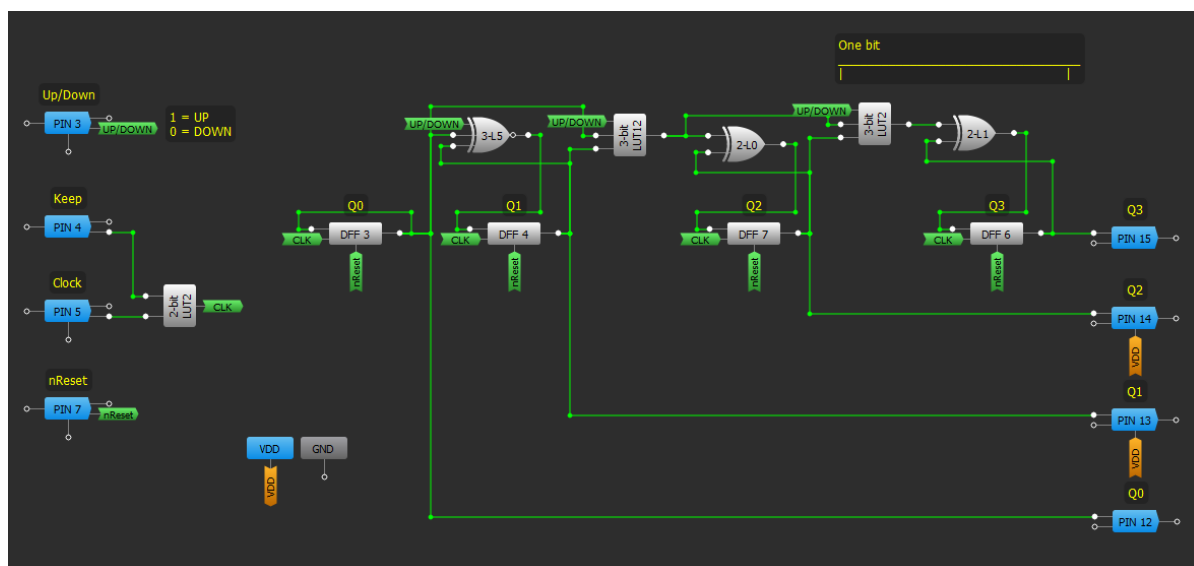

Figure 11: Zoomed Functionality of “16-bit FSM with I2C Output”

## Bidirectional Counter (FSM)

### 6 “9-bit FSM with Parallel Outputs”



**Figure 12: “4-bit FSM with Parallel Outputs”**

The last design is a bidirectional counter with parallel outputs. In order to build this bidirectional counter, connected DFF in series is not enough. For building the bidirectional counter additional logic components are needed. The design is built based on DFFs and LUTs. At any time the user can reset the counter value or change direction of counting. Keep signal (active HIGH) is designated to keep counter value regardless clock signal.

- D0 – PIN#3 (Up/Down)
- D1 – PIN#4 (Keep)
- D2 – PIN#5 (Clock)
- D3 – PIN#7 (nReset)
- D4 – PIN#15 (Q3)
- D5 – PIN#14 (Q2)
- D6 – PIN#13 (Q1)
- D7 – PIN#12 (Q0)

## Bidirectional Counter (FSM)

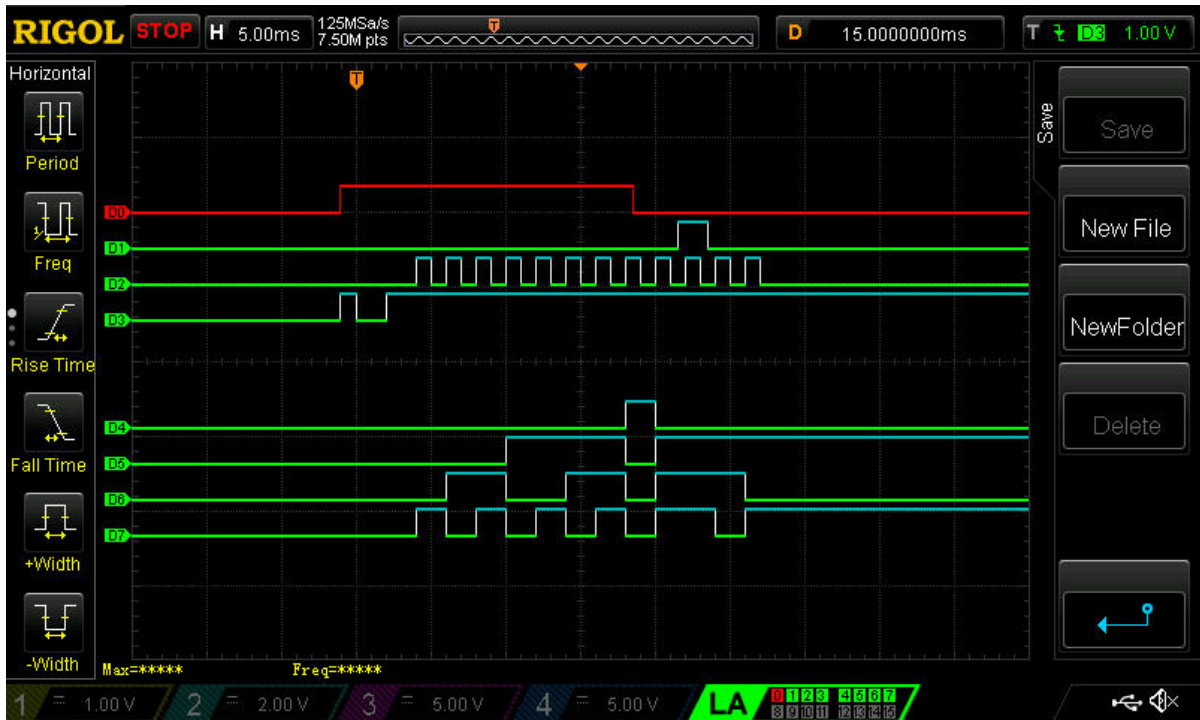

Figure 13: Functionality of “4-bit FSM with Parallel Outputs (Based on Glue Logic)”

In order to increase the number of outputs, “One bit” section (3-bit LUT2, 2-L1, DFF6) should be just copied, as is shown on Figure 14.

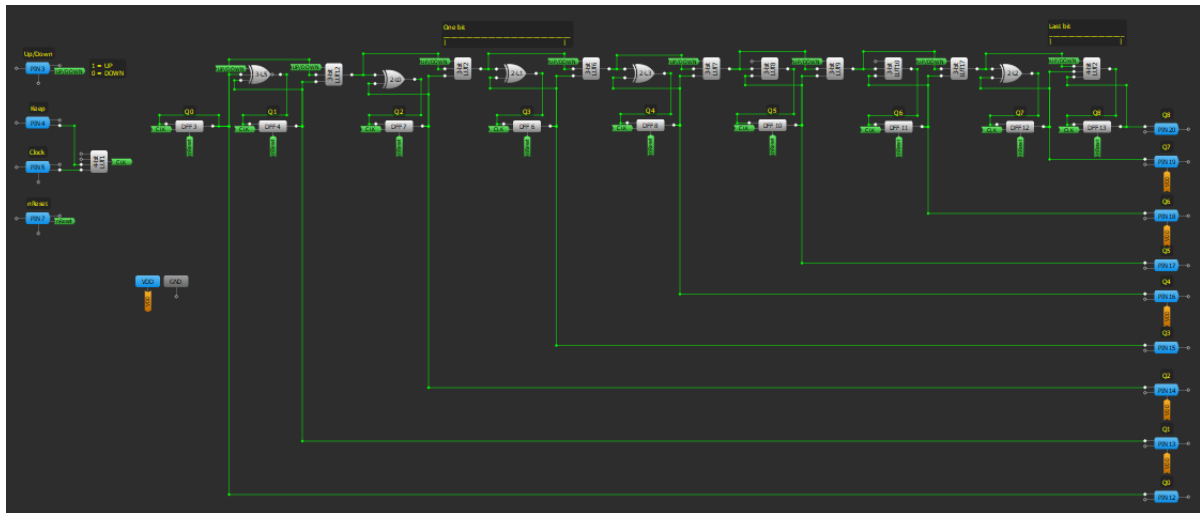

Figure 14: Functionality of “9-bit FSM with Parallel Outputs”

## 7 Conclusions

Counters have become an integral part a most of devices such as real time systems, speedometers, odometers, electricity meters, counting revolutions etc. GreenPAK is ideal for implementing the required counter function with lower cost and small board space.

---

**Bidirectional Counter (FSM)**

**Revision History**

<b>Revision</b>	<b>Date</b>	<b>Description</b>
1.0	19-Jul-2019	Initial Draft

## Bidirectional Counter (FSM)

### Status Definitions

Status	Definition
DRAFT	The content of this document is under review and subject to formal approval, which may result in modifications or additions.
APPROVED or unmarked	The content of this document has been approved for publication.

### Disclaimer

Information in this document is believed to be accurate and reliable. However, Dialog Semiconductor does not give any representations or warranties, expressed or implied, as to the accuracy or completeness of such information. Dialog Semiconductor furthermore takes no responsibility whatsoever for the content in this document if provided by any information source outside of Dialog Semiconductor.

Dialog Semiconductor reserves the right to change without notice the information published in this document, including without limitation the specification and the design of the related semiconductor products, software and applications.

Applications, software, and semiconductor products described in this document are for illustrative purposes only. Dialog Semiconductor makes no representation or warranty that such applications, software and semiconductor products will be suitable for the specified use without further testing or modification. Unless otherwise agreed in writing, such testing or modification is the sole responsibility of the customer and Dialog Semiconductor excludes all liability in this respect.

Customer notes that nothing in this document may be construed as a license for customer to use the Dialog Semiconductor products, software and applications referred to in this document. Such license must be separately sought by customer with Dialog Semiconductor.

All use of Dialog Semiconductor products, software and applications referred to in this document are subject to Dialog Semiconductor's [Standard Terms and Conditions of Sale](http://www.dialog-semiconductor.com), available on the company website ([www.dialog-semiconductor.com](http://www.dialog-semiconductor.com)) unless otherwise stated.

Dialog and the Dialog logo are trademarks of Dialog Semiconductor plc or its subsidiaries. All other product or service names are the property of their respective owners.

© 2020 Dialog Semiconductor. All rights reserved.

## Contacting Dialog Semiconductor

### United Kingdom (Headquarters)

*Dialog Semiconductor (UK) LTD*  
Phone: +44 1793 757700

### Germany

*Dialog Semiconductor GmbH*  
Phone: +49 7021 805-0

### The Netherlands

*Dialog Semiconductor B.V.*  
Phone: +31 73 640 8822

### Email:

[enquiry@diasemi.com](mailto:enquiry@diasemi.com)

### North America

*Dialog Semiconductor Inc.*  
Phone: +1 408 845 8500

### Japan

*Dialog Semiconductor K. K.*  
Phone: +81 3 5769 5100

### Taiwan

*Dialog Semiconductor Taiwan*  
Phone: +886 281 786 222

### Web site:

[www.dialog-semiconductor.com](http://www.dialog-semiconductor.com)

### Hong Kong

*Dialog Semiconductor Hong Kong*  
Phone: +852 2607 4271

### Korea

*Dialog Semiconductor Korea*  
Phone: +82 2 3469 8200

### China (Shenzhen)

*Dialog Semiconductor China*  
Phone: +86 755 2981 3669

### China (Shanghai)

*Dialog Semiconductor China*  
Phone: +86 21 5424 9058